

# SIP Outdoor Intercom with Keypad

**CyberData**

The IP Endpoint Company

Our extensive line of Indoor and Outdoor SIP-enabled Intercoms delivers two-way communication and secure access control for your VoIP phone system. These devices are perfect for settings such as commercial/residential facilities, schools and universities, retail establishments, warehouse and manufacturing plants, SMB, parking garages and shipyards and so much more.

## New Features

- Now Supports 500 Access Codes
- Optional red/green/blue/white strobe kit connection available (part# 011288)
- Integrates with Network Dual Door Strike Relay Module (part# 011375) and Door Strike Relay Module (part# 011269)
- Now with enhanced acoustic echo canceler

## Features

- PoE 802.3af enabled (Power-over-Ethernet)
- 12-key keypad with backlight
- Programmable speed dial
- SIP compliant
- Full-duplex voice operation
- Now supports SRST (Survivable Remote Site Telephony) in a Cisco environment
- Streamlined case design
- Optional Weather Shroud (pictured) for even greater weather protection
- Network web management and firmware download
- Network adjustable speaker volume
- Concurrent SIP and multicast paging
- Dry relay contact for auxiliary control
- Door closure and tamper alert signal
- Downloadable alert, ringtones and callout messages



\*Shown with the 011215 Weather Shroud (sold separately)

## Specifications

Ethernet I/F	10/100 Mbps
Protocol	SIP RFC 3261 Compatible
Power Input	PoE 802.3af compliant or +8 to +12VDC @ 1000mA Regulated Power Supply
Speaker Output	2 Watts Peak Power
On-Board Relay	1A at 30 VDC
Operating Range	Temperature: -40°C to 55°C (-40° F to 131° F) Humidity: 5-95%, non-condensing
Storage Temperature Storage Altitude	Temperature: -40° C to 70° C (-40° F to 158° F) Up to 15,000 ft. (4573 m)
IP Rating	IP65
Payload Types	G711, A-law and $\mu$ -law, G.722
Dimensions	7.480 inch [190 mm] Length 2.284 inch [58 mm] Width 5.118 inch [130 mm] Height
Weight Boxed Weight	2.8 lbs. (1.27 kg) 4.0 lbs. (1.81 kg) Weather Shroud is 1.2 lbs. (0.54 kg)
Compliance	CE; EMC Directive – Class A EN 55032 & EN 55024, LV Safety Directive – EN 60950-1, RoHS Compliant, FCC; Part 15 Class A, Industry Canada; ICES-3 Class A, IEEE 802.3 Compliant
Warranty	2 years limited
Part Number	011214 011215 Weather Shroud (sold separately)

The following Intercom models are also available:



SIP Intercom with Keypad (Wall Mount)  
#011113



SIP Intercom with Keypad (Flush Mount)  
#011123



SIP Outdoor Intercom  
#011186



SIP Emergency Intercom  
#011209

**CyberData**

The IP Endpoint Company

# SIP Outdoor Intercom with Keypad

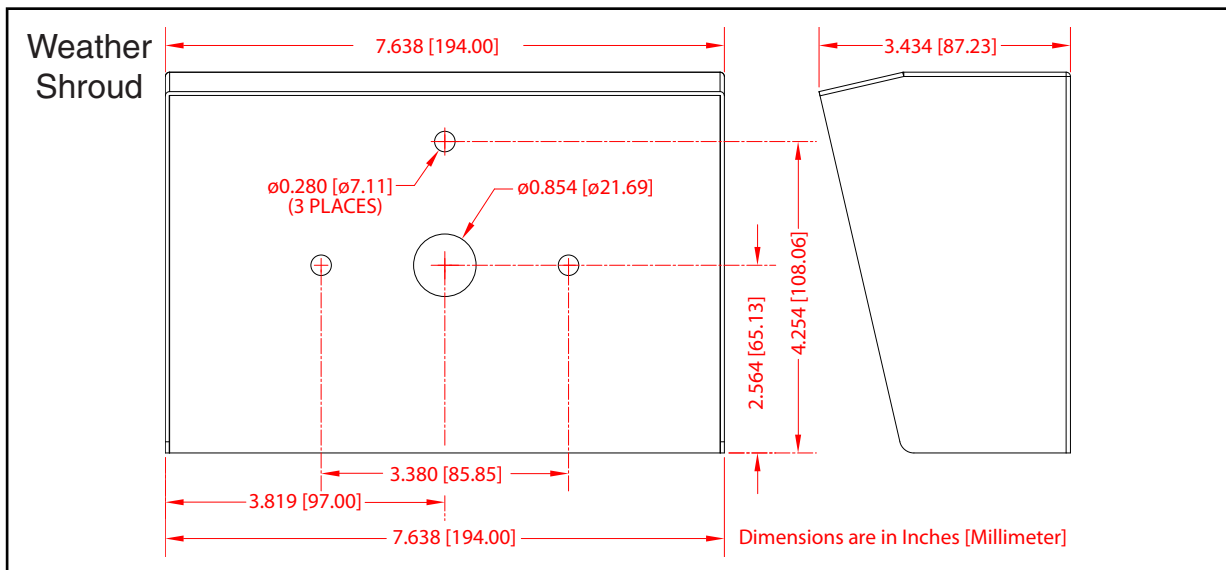
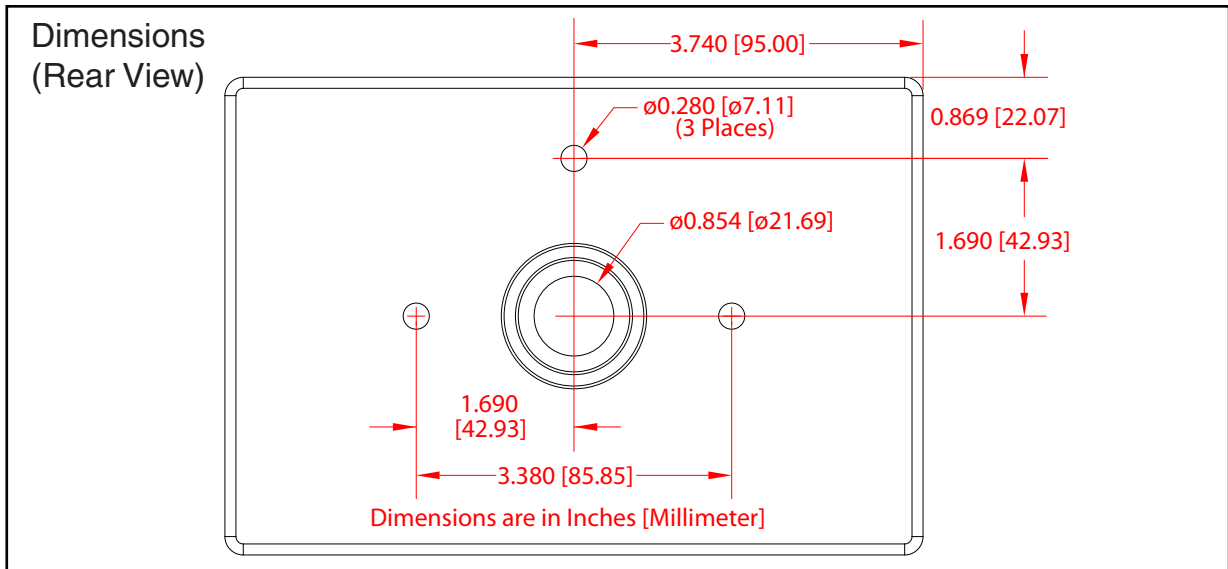
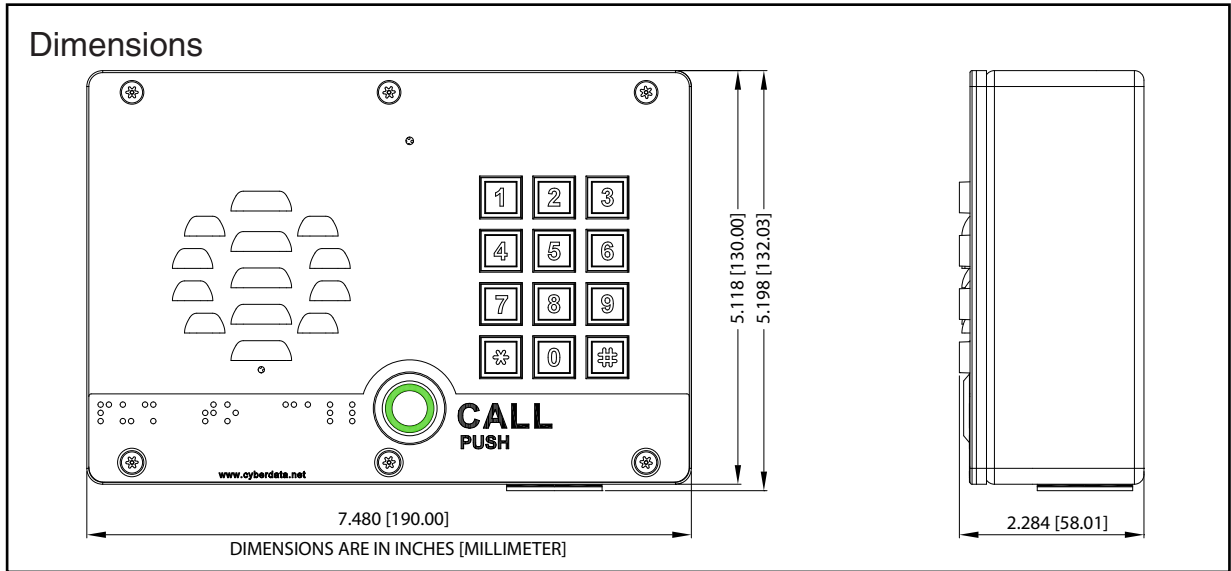

# SIP Outdoor Intercom with Keypad

